

# Robertshaw®

# 9600

DIGITAL  
PROGRAMMABLE  
THERMOSTAT

INTEGRATED COMFORT SOLUTIONS™



ELECTRIC



GAS



5 - 2 Day Programmable  
1 Heat / 1 Cool

**User's Manual**  
Quick Start  
Installation and  
Programming

110-653C



## Installation Guide

### IMPORTANT SAFETY INFORMATION WARNING:

- Always turn off power at the main power source by unscrewing fuse or switching circuit breaker to the off position before installing, removing, cleaning, or servicing thermostat.
- Read all of the information in this manual before installing or programming this thermostat.
- This is a 24V AC low voltage thermostat. Do not install on voltages higher than 30V AC.
- All wiring must conform to local and national building and electrical codes and ordinances.
- Do not short (jumper) across terminals on the gas valve or at the system control to test installation. This will damage the thermostat and void the warranty.

# Features

- Four setpoints for weekday programming—two setpoints for weekend comfort.
- Two AA ENERGIZER brand batteries retain program memory even during power outages.
- Low battery indicator.
- Fahrenheit/Celsius display option.
- Programmable from 45°F (4°C) to 90°F (32°C).
- Accuracy within ± 1 degree.
- Adjustable temperature differential: 1-3 degrees.
- Maintains summer and winter programming.
- Low temperature freeze protection. While in heat mode, thermostat will mechanically turn on heat if temperature drops to 40°F (4°C) - even if batteries are missing or drained.
- Automatic heating shutdown if temperature exceeds 90°F (32°C).

## Replacing Existing Thermostat

1. Turn off power to heating and cooling system.
2. Remove cover of old thermostat to expose wires. Do not disconnect wires. (See Figure 1)
3. Label wires per Table 1.

**Table 1**

Old Label	New Label	Description
M, 4, RH, R5 or R	RH	Heat Transformer, hot side
V or RC	RC	Cooling Transformer, hot side
Y or Y6	Y	Cooling control
H, W or 4	W	Heating control
F or G	G	Fan control relay
C*	Y or None	Either cooling control or common side of transformer

**\*NOTE:** ON SOME OLDER MODELS, THE C TERMINAL CAN BE EITHER THE COOLING CONTROL OR THE COMMON SIDE OF THE TRANSFORMER. CHECK FURNACE WIRING DIAGRAM TO VERIFY C TERMINAL. IF IT IS THE COMMON SIDE OF THE TRANSFORMER, CAP THE WIRE AND TUCK INTO THE WALL. IF IT IS THE COOLING CONTROL, CONNECT TO THE Y TERMINAL.

4. After labeling wires, remove wires from terminals.
5. Remove existing thermostat base from wall.
6. Refer to the following section for instructions on how to install thermostat.

Figure 1

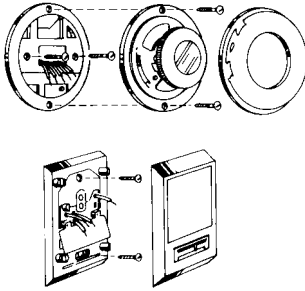

## Installing Item 9600 Thermostat

**NOTE:** FOR NEW INSTALLATIONS, MOUNT THERMOSTAT ON AN INSIDE WALL, 4-5 FEET ABOVE THE FLOOR. DO NOT INSTALL BEHIND A DOOR, IN A CORNER, NEAR AIR VENTS, IN DIRECT SUNLIGHT, OR NEAR ANY HEAT OR STEAM GENERATING FIXTURES. INSTALLATION AT THESE PLACES WILL AFFECT THERMOSTAT OPERATION.

1. Turn power off to the heating and cooling systems.
2. Place COOL-OFF-HEAT in OFF position.

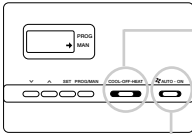

3. Place  AUTO-ON switch into AUTO position.
4. Remove the cover using a coin or screwdriver.

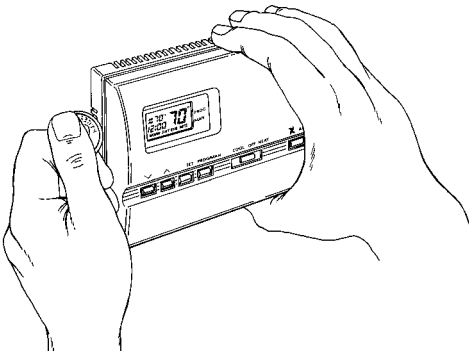
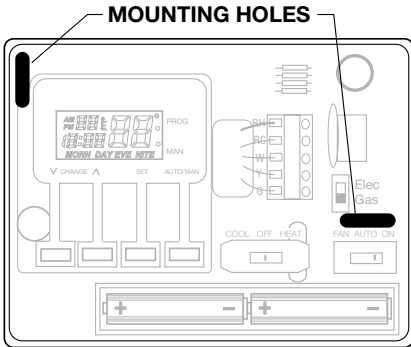

Figure 2

5. Place thermostat against the wall at desired location. Make sure wires will feed through opening on base of thermostat.
6. Mark placement of mounting holes (see Figure 3). Set base aside.

Figure 3



7. Drill the marked holes using a 3/16" drill bit. Note: Enclosed plastic anchors do not require a drilled hole for drywall.
8. Tap plastic anchors into the wall.
9. Align base with plastic anchors and feed wires through opening (see Figure 4).

Figure 4

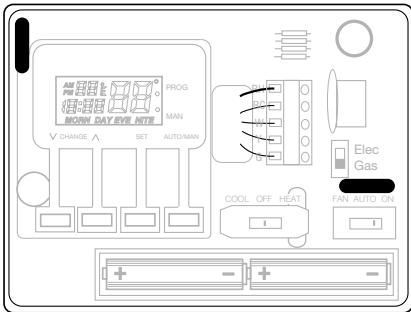

10. Secure base to wall with supplied screws.
11. Connect wires to terminal strip. Refer to wiring diagrams on other side of this sheet. Make sure wire connections are secure.
12. Place fan option switch into either the ELEC or GAS position depending on the type of furnace. Refer to Figure 5.

Figure 5

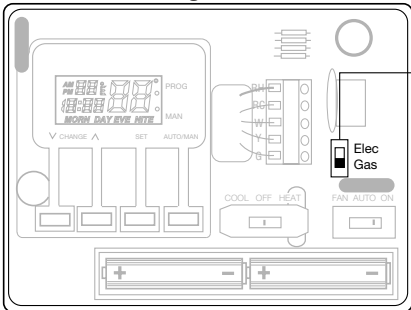

**FAN  
OPTION  
SWITCH**  
Controls  
fan delay.

13. Install two AA ENERGIZER brand batteries or equivalent into battery compartment. Be sure to match positive (+) ends of batteries with positive (+) battery terminals in the battery compartment. The display will show as follows:

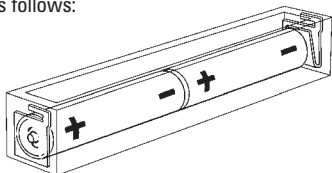

14. Replace cover on thermostat by snapping into place.  
 15. Turn on power to system. Test thermostat as described in the section **To Test Thermostat**.

## Programming Guide

### Set Time of Day, Day of Week, Temperature Differential

1. Press and hold SET. Press PROG/MAN. Release simultaneously.

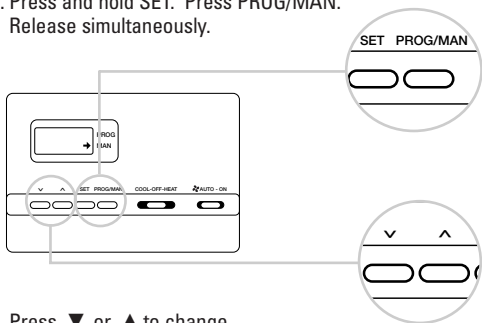

Press ▼ or ▲ to change time of day.

2. Press



Press



to change day of week

1	=	MO
2	=	TU
3	=	WE
4	=	TH
5	=	FR
6	=	SA
7	=	SU

3. Press



Press



to change temperature differential\*

\*THE TEMPERATURE DIFFERENTIAL IS FACTORY PRESET AT 1°. THIS MEANS THAT WHENEVER THE ROOM TEMPERATURE CHANGES BY ONE FULL DEGREE FROM THE TEMPERATURE SETTING, THE SYSTEM WILL TURN ON. IF THE SYSTEM TURNS ON TOO OFTEN, INCREASE THE TEMPERATURE DIFFERENTIAL.

## Changing Fahrenheit (F) to Celsius (C)

Press and hold SET.



Press



Release both simultaneously.

## Setting Daily Programming

1. Place COOL-OFF-HEAT switch in COOL position.

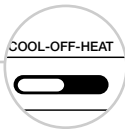
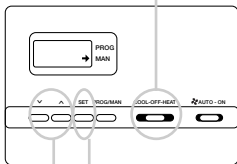

2. Press SET.



3. Press ▼ or ▲ to change MORN time.



#### 4. Press SET.

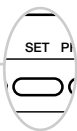
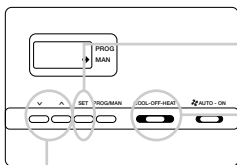

#### 5. Press ▼ or ▲ to change MORN temperature.

#### 6. Repeat Steps 2-5 for DAY, EVE, and NITE.

#### 7. Shift COOL-OFF-HEAT switch to HEAT position.

#### 8. Repeat steps 2-6 to program HEAT (winter) settings.

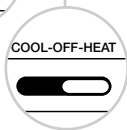
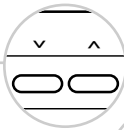

**NOTE:** BOTH SUMMER AND WINTER PROGRAMS USE THE SAME TIME SETTINGS.

Your thermostat is now programmed for summer and winter operation. It will follow the four settings (MORN, DAY, EVE, NITE) for weekday operation and two settings (MORN and NITE) for weekend operation. Adjust the program at any time by following the steps as outlined above.

## Begin Programmed Operation

#### 1. Place AUTO-ON switch into AUTO.

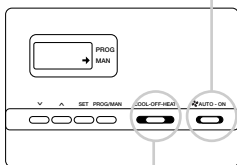

#### 2. Place COOL-OFF-HEAT switch into COOL or HEAT depending on the season.

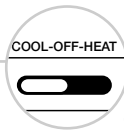

SUMMER

#### 3. Press PROG/MAN button until indicator is in PROG position.

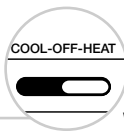

WINTER

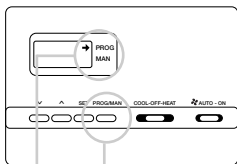

# Temporary Program Override

To temporarily increase or decrease temperature:

Press ▼ or ▲.

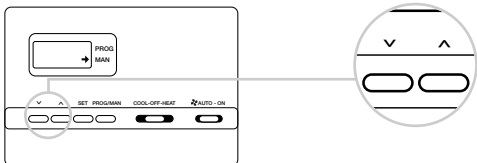

The thermostat will automatically return to the program at the next scheduled setting change.

# Manual Operation

1. Press PROG/MAN until indicator is in MAN position.

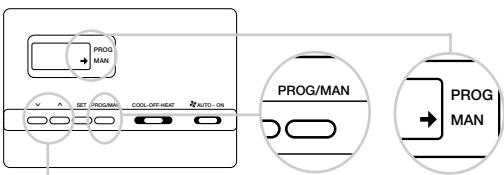

2. Press ▼ or ▲ to adjust temperature settings.



# Reset

To reset the thermostat to factory preprogrammed conditions, press the RESET button located directly to the right of the display.

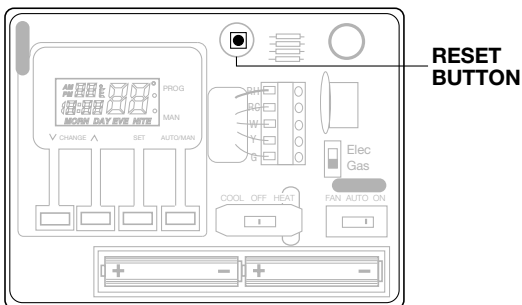



## To Test Thermostat

**WARNING:** DO NOT SHORT (JUMPER) ACROSS TERMINALS OF GAS VALVE OR SYSTEM CONTROL TO TEST OPERATION. THIS WILL DAMAGE THE THERMOSTAT AND VOID YOUR WARRANTY.

**CAUTION:** DO NOT SWITCH SYSTEM TO COOL IF THE TEMPERATURE IS BELOW 50°F (10°C). THIS CAN DAMAGE THE AIR CONDITIONING SYSTEM AND CAUSE PERSONAL INJURY.

1. Place the COOL-OFF-HEAT switch into the COOL position.

COOL-OFF-HEAT



2. Press the ▼ button until the temperature setting is at least 3 degrees below the room temperature. The air conditioning system should turn on within a few seconds.

**NOTE:** THERE IS A BUILT IN 5-MINUTE DELAY ON BREAK FOR COMPRESSOR PROTECTION. A SECOND ATTEMPT TO TURN ON THE AIR CONDITIONING WILL RESULT IN A 5-MINUTE DELAY IN COMPRESSOR ACTIVATION.

3. Put the COOL-OFF-HEAT switch into the OFF position. The air conditioning system should turn off. The fan may continue to run for a short period of time.

COOL-OFF-HEAT

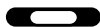

4. Put the COOL-OFF-HEAT switch into the HEAT position.

COOL-OFF-HEAT



5. Press the ▲ button until the temperature setting is at least 3 degrees above room temperature. The heating system should turn on. The fan may not turn on immediately, depending on the fan delay built into the furnace.

6. Put the COOL-OFF-HEAT switch into the OFF position. The heating system should turn off. Once again, the fan may have a delay.

COOL-OFF-HEAT

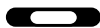

7. Put the  AUTO-ON switch to the ON position. The blower fan should turn on.

 AUTO - ON



8. Put the  AUTO-ON switch to the AUTO position. The blower fan should turn off.

 AUTO - ON



# Troubleshooting

Symptom	Remedy
Thermostat does not turn on system.	Check wiring. (See INSTALLATION) Check fuse. Replace with 2 amp Slo-Blo fuse if fuse has opened.
Thermostat turns on and off too frequently.	Increase temperature differential. (See PROGRAMMING)
Display is blank, flashing or constant LO BAT.	Replace batteries.
Weekend program follows four adjustment settings.	Verify that day of week is set correctly. (See PROGRAMMING)
System fan does not operate properly.	Move fan option switch to either gas or electric, to match system. (See INSTALLATION)
Time shown on display is not the current time of day.	Change time of day setting. (See PROGRAMMING)
Thermostat does not follow program.	Thermostat in MANUAL mode. (See PROGRAMMING). Thermostat may not have been programmed in HEAT or COOL position. Verify program. Check AM/PM indicators at time of day and programmed time changes. (See PROGRAMMING) Verify program and day of week are correct. (See PROGRAMMING)

**If problems with thermostat cannot be solved, call:**

Technical Support: (800) 445-8299

Monday-Friday 7:30-5:30 CST

For after hours service, a 24-hour automated help line is available.

For warranty returns, send thermostat, shipping prepaid to:

**MAPLE CHASE COMPANY**

Warranty Department  
2820 Thatcher Road  
Downers Grove, IL 60515

# Wiring Diagrams

The following is just a sample of the most common types of HVAC systems. Refer to your system's installation manual for wiring information.

## HEAT/COOL 4-WIRE SINGLE TRANSFORMER

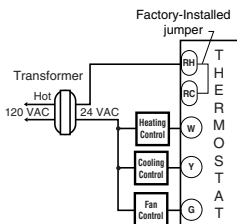

## HEAT ONLY 3-WIRE SINGLE TRANSFORMER

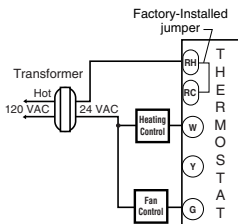

## HEAT ONLY 2-WIRE SINGLE TRANSFORMER

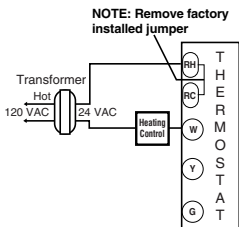

## COOL ONLY 3-WIRE SINGLE TRANSFORMER

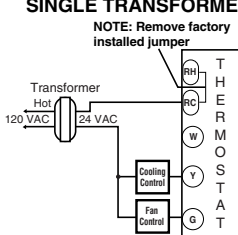

## HEAT/COOL 5-WIRE TWO TRANSFORMER

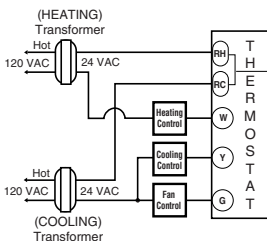

**NOTE: Cut center of factory installed jumper and bend back**

**CAUTION: Both transformers must be in phase or damage to the equipment and thermostat may result.**

## FIVE-YEAR LIMITED WARRANTY

**Maple Chase Company** warrants to the original contractor installer or to the original consumer user, each new Robertshaw thermostat to be free from defects in materials and workmanship under normal use and service for a period of five (5) years from date of purchase. This warranty and our liability does not apply to batteries or the merchandise that has been damaged, caused by misuse, neglect, mishandling, alterations, improper installation, or use in a way other than in accordance with Maple Chase Company recommendations and instructions.

**Maple Chase Company** agrees to repair or replace at its option any thermostat under warranty provided it is returned within the warranty period, postage prepaid, with proof of the date of purchase. Cost of thermostat removal or reinstallation is not the responsibility of Maple Chase Company.

Repair or replacement as provided under this warranty is the exclusive remedy of the consumer. **Maple Chase Company** shall not be liable for any incidental or consequential damages for breach of any express or implied warranty on this product, or under any other theory of liability. Except to the extent prohibited by applicable law, any implied warranty of merchantability or fitness for a particular purpose on this product is limited to the duration of this warranty.

Some states do not allow the exclusion or limitation of incidental or consequential damages, or allow limitations on how long an implied warranty lasts, so the above limitations or exclusions may not apply to you. This warranty gives you specific legal rights, and you may also have other rights which vary from state to state.

 **Maple Chase Company**  
2820 Thatcher Road  
Downers Grove, Illinois 60515  
United States of America